

SOPHIA SL - TYP 841

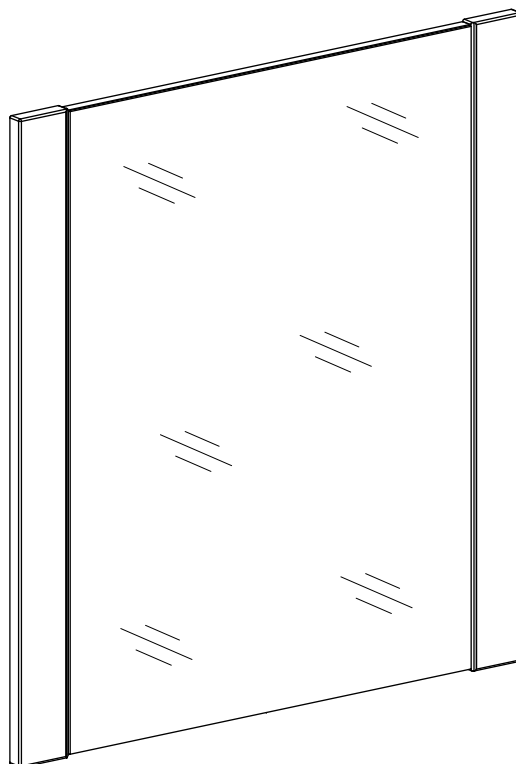

Dim.	Col.-No	Qty
650	802	1

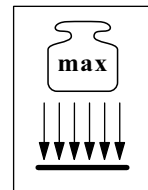

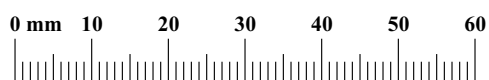
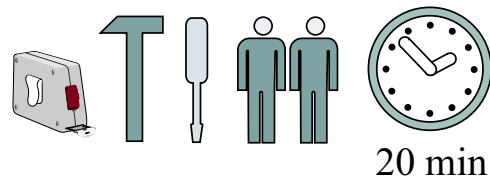
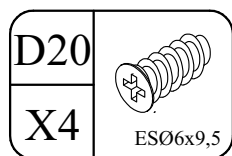
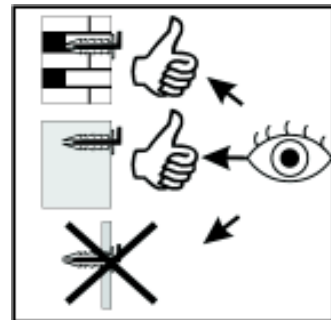
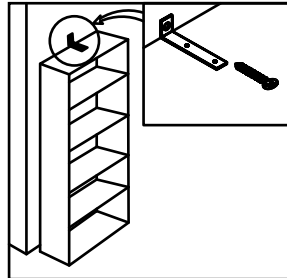
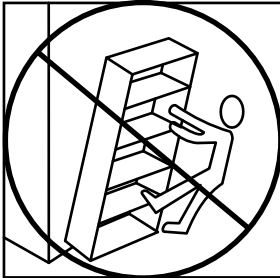
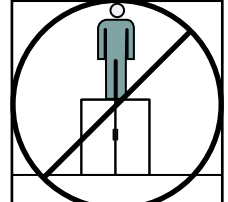
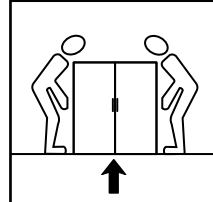
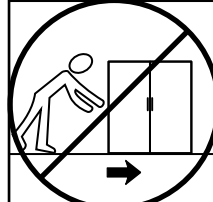
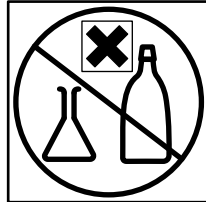
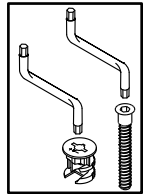
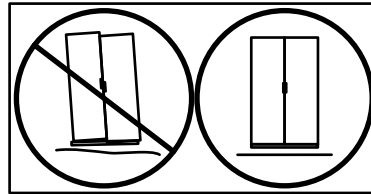
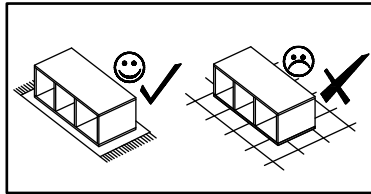
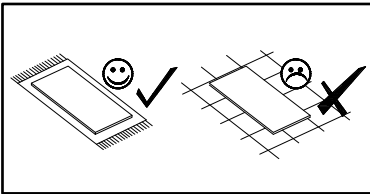
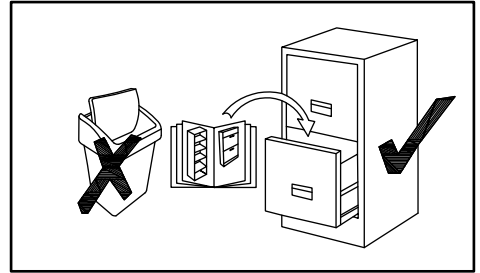
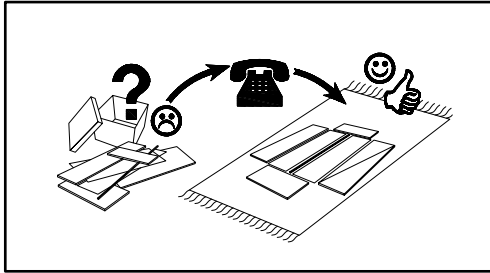
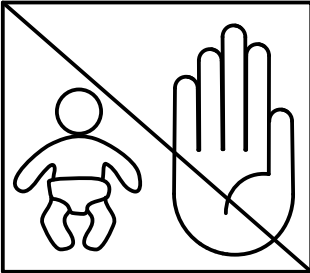

1

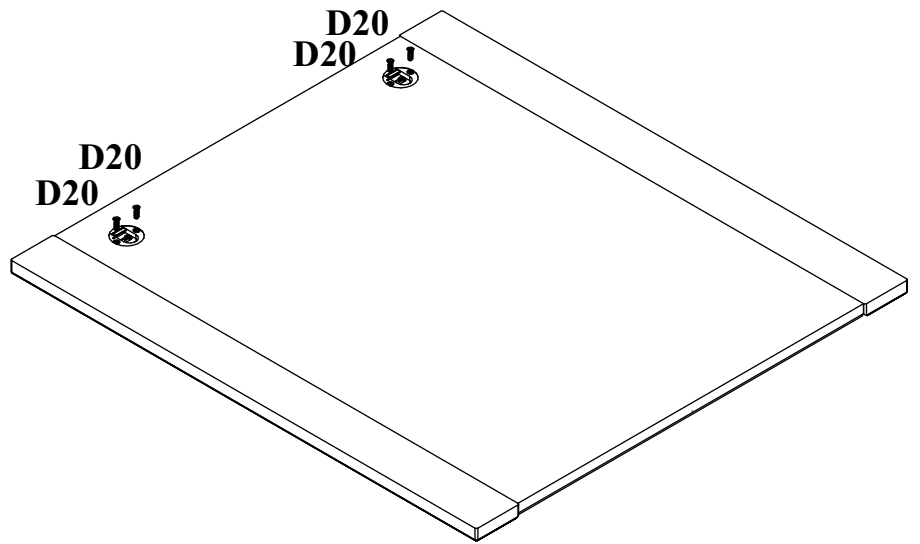
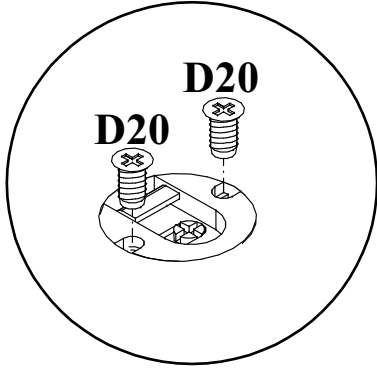

2

