

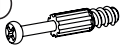

<b>B1</b>		$\phi$ 8x28	x4
<b>T1</b>			x4
<b>M1</b>			x4
<b>C2</b>		$\phi$ 20	x4

1



2

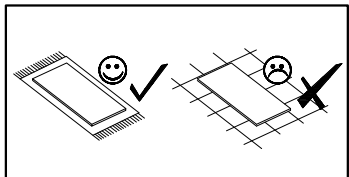
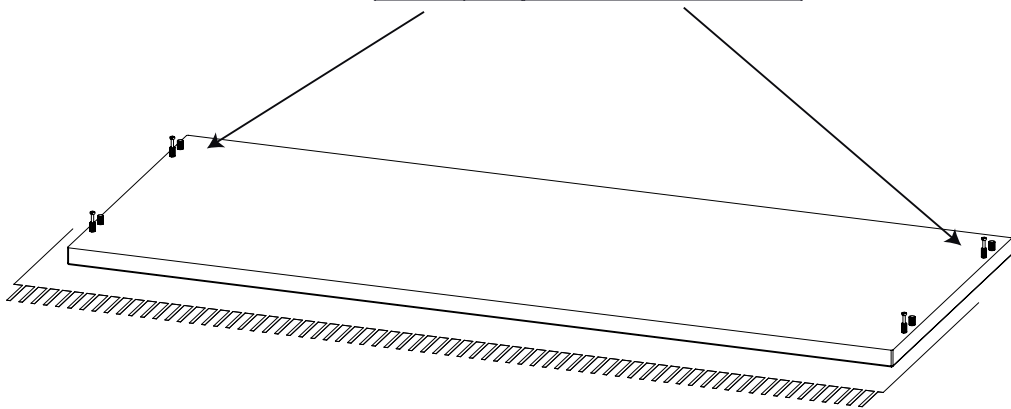
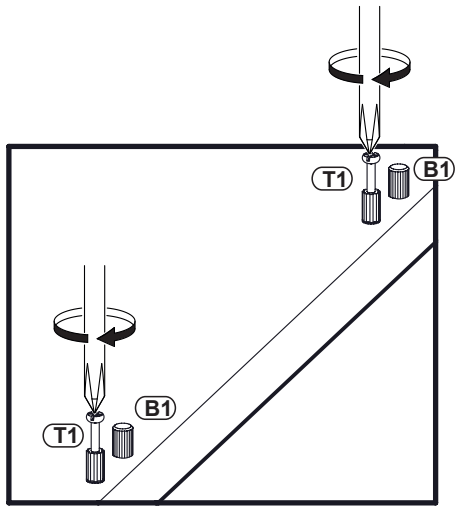
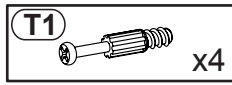
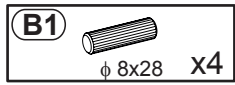
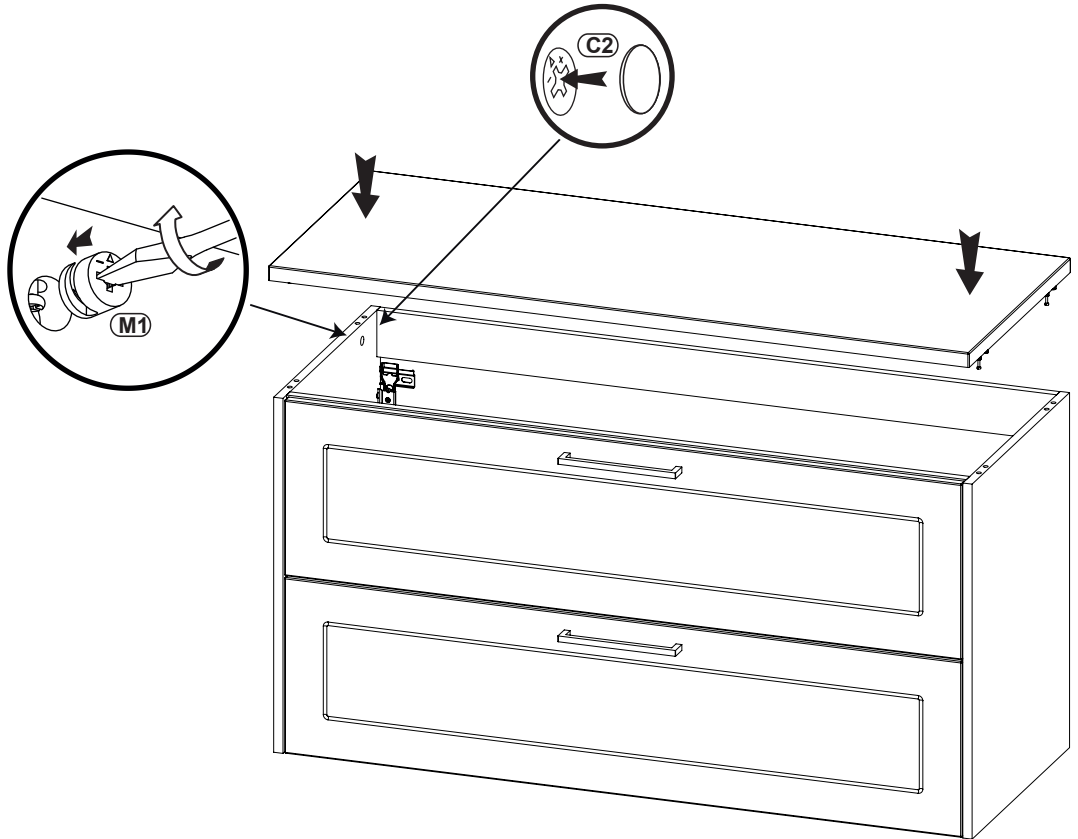
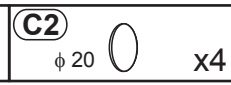

Typ 854